

REVISION RECORD				
REV	ECO	DESCRIPTION	DRFT	DATE

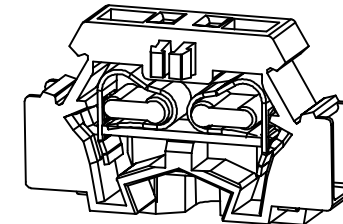
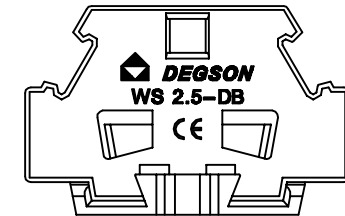
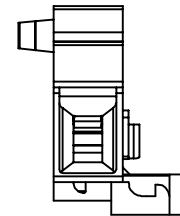
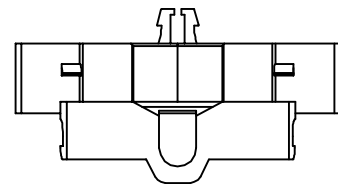
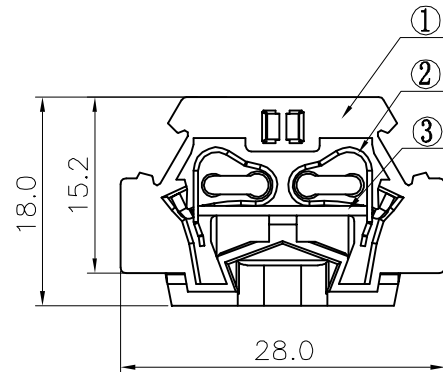
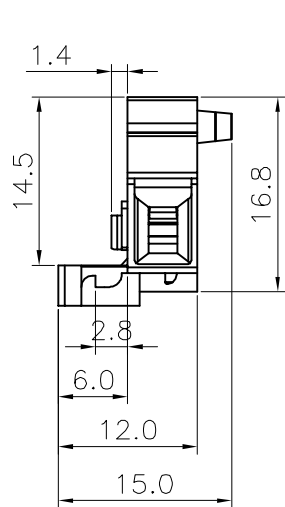
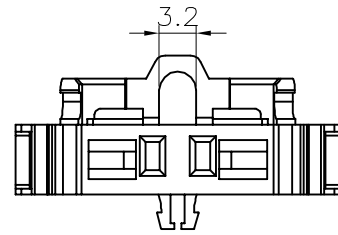

Notes:

- Rated voltage/current: UL1059 300V/15A
IEC 500V/24A
- Operation temperatures: -40°C ~ +105°C
- Withstanding Voltage: AC3000V/1min
- Insulation Resistance: 5000MΩ /DC1000V
- Wire Range: 28~14AWG, 2.5mm²
- Undimensioned Tolerances:

Pitch range in mm		Nominal dimension range in mm						—
to	over	over	to	over	over	over	—	
6	10	10	30	60	100	150	∩	
6	10	24	30	60	100	150	◇	
±0.10	±0.15	±0.25	±0.2	±0.3	±0.5	±0.7	±1.0	
							0.05/10	

3	WS 2.5-DB-Current-Carrier	6152B00010(H)	1	Copper	SnCe
2	DC242-5.0-Shrapnel	X000000990(H)	2	Stainless steel	
1	WS 2.5-DB-Housing	6152A0Y01A(H)	1	PA66	UL94V-0
ITEM	NAME OF PART	NO. OF PART	Q'TY	MATERIAL	NOTES
REVISION LISTS	← INCH →	DFTD Yangys	DATE 07/02/08*	宁波高正电子有限公司 DEGSON ELECTRONICS CO., LTD NAME WS 2.5-DB-01P-1Y-00A(H) DRAWING NO. WS 2.5-DB-E01 SIZE A3 REV TO 07/02/08* /PART NO. DO NOT SCALE DRAWING SHEET 1 OF 1	
	TOLERANCES EXCEPT AS NOTED	CHKD	DATE		
	MM	MFO	DATE		
	.0 ±	APPVL	DATE		
	.000 ±	MATERIAL :			
ANGLES ± 1°	G. E :				
THIRD ANGLE PROJECTION	FINISH :				
	SCALE : 1:1				