

REVISION RECORD

REV	ECN	DESCRIPTION	DRFT	DATE
-----	-----	-------------	------	------

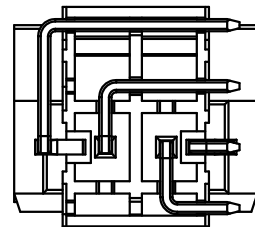
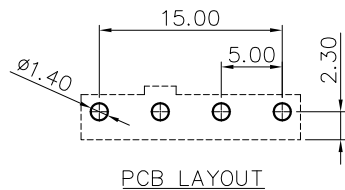
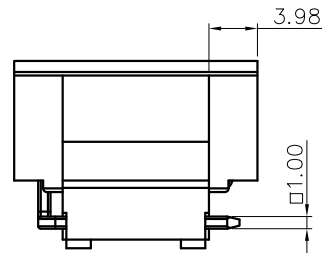
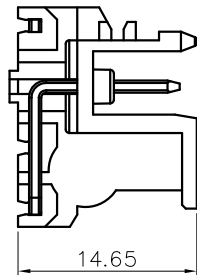
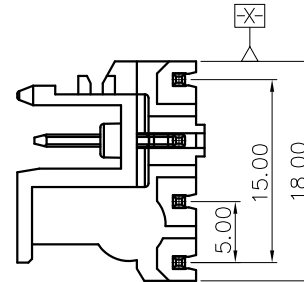
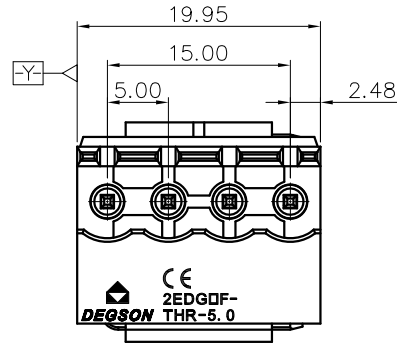
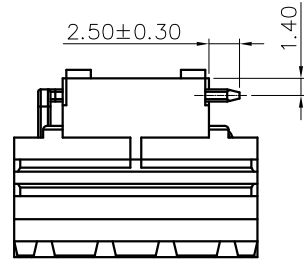

NOTES1:

UL Standard

- 1.Rated voltage/current : 300V / 15A
- 2.Withstanding voltage : AC1600V/1Min.

IEC Standard

1.		2	2	3
Pollution degree		II	III	III
Overvoltage category		4.0KV	4.0KV	4.0KV
Rate impulse voltage(KV)		400V	320V	250V
Rate voltage(V)		20A		
Rate current(A)				

NOTES2:

- 1.Dimension shall be interpreted per ASME Y14.5-2009
- 2.Pitch : 5.0mm, Poles : 04P
- 3.Operating temperature: -40°C~+120°C
- 4.Undimensioned tolerances:

Pitch range in mm		Nominal dimension range in mm					0.1/10		
TO	Over	TO	Over	TO	Over	TO	≤		
6	6	10	10	30	60	100			
	±0.20		±0.30		±0.50		±1.00	±1.30	±2'

5.RoHS Compliance

2EDGRF - THR - 5.0 - 04P - 1Y - 00A (H)
 (Series No.) (Pitch) (Poles) (Single Pitch) (Color):3.(Black) 5.(Orange)
 (Through holes Reflow) (RoHS) 00A-(Standard)

DETACHED LISTS	PART NO.:	宁波高松电子有限公司 NINGBO DEGSON ELECTRICAL CO., LTD			
	APPD:	NAME: 2EDGRF-THR-5.0-04P-1Y-00A(H)			
	CHKD:	TITLE: CUSTOMER DRAWING			
	DRFT:	DRAWING NO.:		REV	DO
THIRD ANGLE PROJECTION		MM (INCH)	DO NOT SCALE DRAWING	SHEET	1/1
			SCALE	1:1	